

Performances

1160.8PE/PiE

DESIGN

The Performances range of rotisseries has been especially designed for high-volume cooking with high output and speed, while retaining excellent cooking quality. Well designed, user friendly and reliable the Performances is used by leading super-markets and chain restaurants throughout the world.

Conscious of the high energy cost involved for our clients, the Performances rotisserie has energy saving infrared burners, patented by Rotisol. A wide array of accessories enable the rapid roasting of a variety of products.

FEATURES

- Energy efficient
- Tempered K-glass doors
- Independent motor for each spit
- Equipped with bottom drip tray with built-in drainage
- Reinforced and anti warping heating element
- Powerful halogen lamp
- Delivered with 8 prongless spits (CUI1160)
- Illuminated sign «Rotisserie»
- Base on casters with brakes

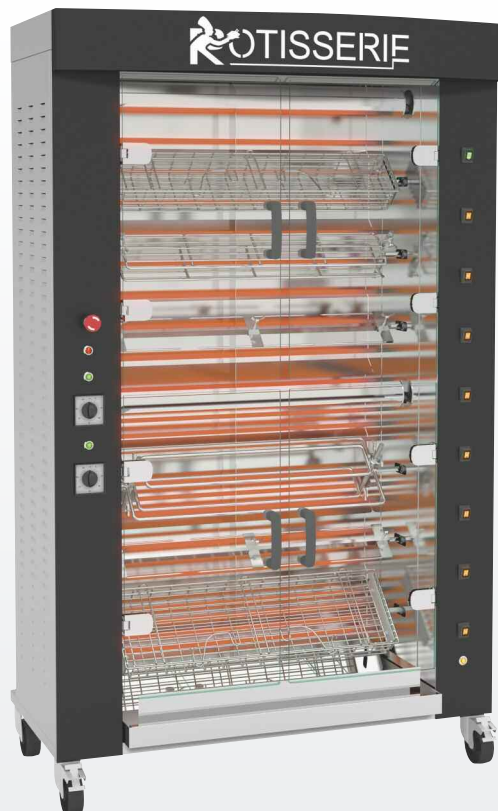





1160.8PE
Black enamel

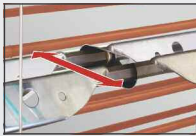
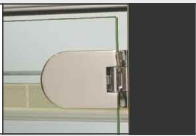
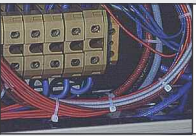

TECHNICAL DETAILS

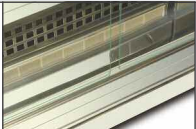
Overview of some of the standard features.

	Independent motors adjustable in depth for each spit		Robust hinges designed for heavy use, with integrated locking in open and closed positions		Easy and protected access to the compartment of connections and electrical components.
	Reinforced heating elements with stainless steel holders to keep them in place and removable stainless steel panels for easy cleaning.		Anti-scald K-glass reduces external thermal radiation (energy saving). Glass overlaps drip pan to keep splatters inside (anti-slip protection).		Removable inside side-panels doubles protection from grease seeping into motors and other sensitive parts

ACCESSORIES

A variety of accessories are available. See video of available [accessories](#) and of [vertical spit system](#) online.

CUI1160 Anti-cutting prongless V-spit.		PID1160 Tray for unspitting.		BRC1160 Rectangular basket spit.	
BS1160 Spit for ham / turkey.		BRRO1160 Roast-clamp spit.		BA1160 Lamb/suckling-pig spit.	
BCR1160 Spatchcock chicken basket.		DEC Spit mover.		AT Gas lighter.	

Front view

Rotisserie with roof (optional)
and base on casters (optional)

Side view

Rotisserie with roof (optional)
and base on casters (optional)

Top view

Rotisserie with roof (optional)
and base on casters (optional)

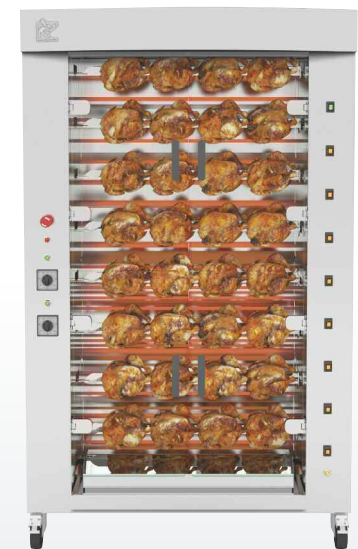
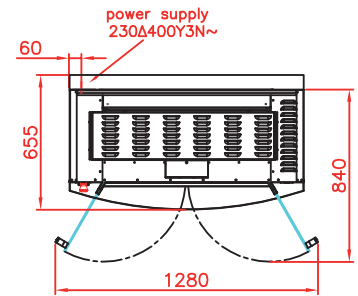
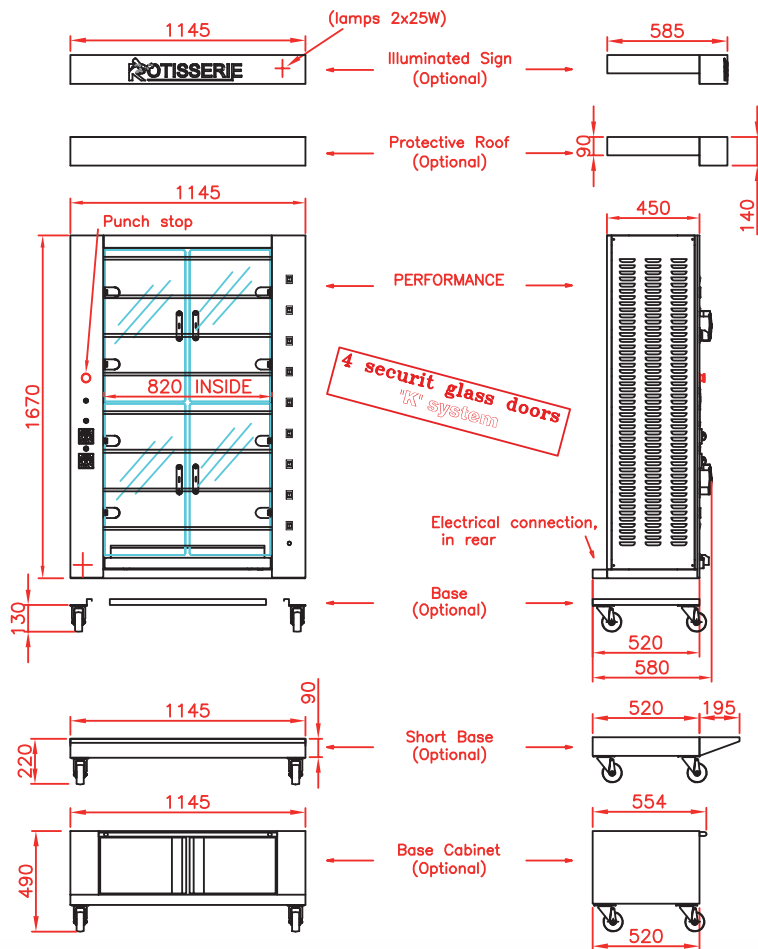

1160.8PiE
Stainless steel

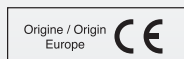

Revised :
June 2021



SPECIFICATIONS

Capacity roasted chickens	32/40 poultries
Power supply	400 Volts 3 phases+neutral+earth
Electrical power	23.5 kW
Weight and size (HxDxW)*	195 kg ; 1890 x 655 x 1145 mm
Shipping weight and size*	256 kg ; 2000 x 750 x 1210 mm
Guarantee	1 year on parts

* with a stand or base cabinet (optional)

DISTRIBUTOR / AGENT

Rotisol S.A.S.

Zone industrielle La Trentaine, Avenue Gustave Eiffel

77507 Chelles cedex - FRANCE

s.bennell@rotisol.com - Tel : +33 1 64 21 80 00

www.rotisol.com